



FC722

Cerberus® PRO

Fire control panel



Series FS720 (IP4)

- Compact, prefabricated microprocessor-controlled fire control panel for the connection of up to 252 addresses
- Fire control panel can be used as stand-alone version or networked
- Up to 64 stations (fire control panels and fire terminals) can be connected in one network
- Integrated emergency operation function
- Redundant network node, degrade operation according to EN 54
- Fast Ethernet interface for heterogeneous network
- Integrated user-friendly operating unit
- Optional printer, key switch, LED indicators
- Slots for RS232, RS485 serial ports
- Emergency power supply for up to 72 h emergency power time
- Detection and automatic read-in (auto configuration) of all C-NET devices, providing immediate simple operation
- Processes signals from the Cerberus PRO FD720 detector series
- Floor repeater devices, alarm devices and mimic displays in the detector loop (C-NET)
- Flexible programming of complex applications and controls
- Stored data can be uploaded via remote access
- Firmware download of all processor controlled control panel components

System overview

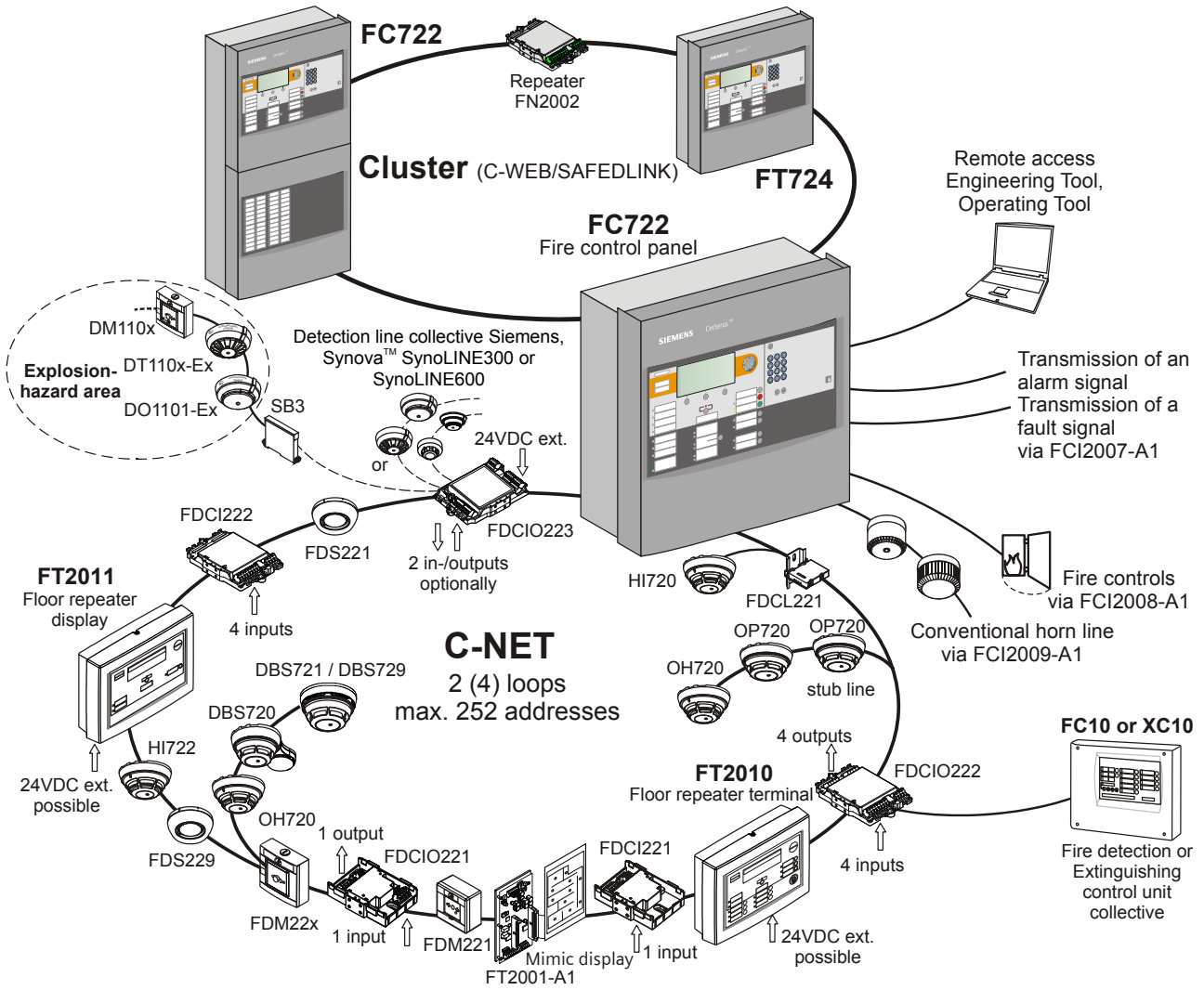

Networking topologies

Up to 32 fire control panels and fire control terminals can be connected in a single cluster (C-WEB/SAFEDLINK) or up to 16 stations when the cluster is connected to a danger management system.

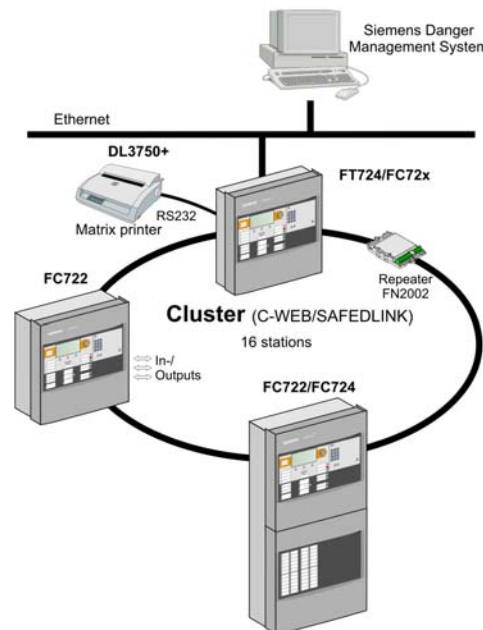

Using a fiber-optic Backbone (C-WEB/LAN) up to 14 of the above mentioned clusters (with up to 16 stations each) can be networked. The entire network may contain up to 64 stations.

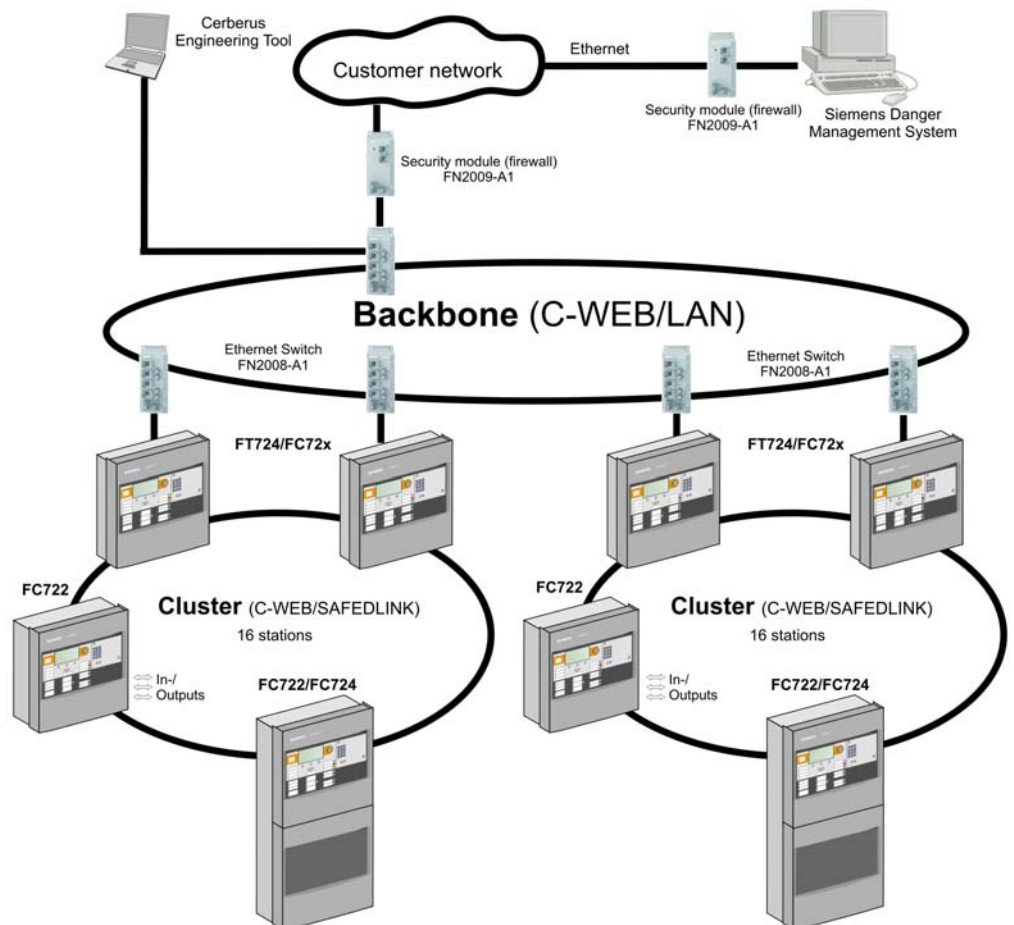

→ For details about system networking, please refer to product data sheet A6V10227649.

Characteristics

- The FC722 is a compact fire control panel with an integrated operating unit that can process signals from FD720 devices.
- The control panel can be used as a stand-alone unit or in a network.
- The control panel can be programmed with the user-friendly Cerberus-Engineering-Tool to create a system with great versatility.
- All detector lines are monitored for ground faults.
- Adaptation of the user text directly on the terminal or with the software engineering tool.
- Up to 2000 events can be stored according to various criteria.
- Automatic summer/winter time change.
- Connection of Siemens Danger Management System

Functional elements

Operating unit

The following are located on the operating unit:

- CPU module and the electronics for the operating unit
- Ethernet connection
- Slots for RS232, RS485 modules and networking modules (SAFEDLINK)
- Space for 'Kaba' or 'Nordic' key switch
- Space for event printer (except FC722-YZ)

Periphery board

The following are located on the periphery board:

- Connection terminals for C-NET loops, remote transmission (alarm, fault), horn output, programmable control inputs/outputs, monitored alarm and fault output, degrade supply, power supply
- Plug-in position for loop extension (C-NET)

Power supply 70 W or 150 W, emergency power supply

The power supply supplies the hardware and charges the batteries

- The batteries supply the emergency power in case of power failure

Housing

A pivoting mounting panel can be installed on the housing backplane to allow installation of:

- 1 fire brigade periphery module (for Germany)
- 1 sounder module (can also be mounted onto the U-rail TS35)

Configuration

The FXS7212 Cerberus-Engineering-Tool permits the system to be adapted to specific customers' requirements.

Application ranges

The FC722 is ideally suited for applications, e.g. in workshops, hotels, etc. or when networked as part of much larger applications.









The FC722 can be used by the flexible cross-linking possibilities however also for extensive systems.

Operation

Each control panel has an integrated operating unit. Additionally the control panel can be operated from another separate FT724 operator terminal.

→ For details and further information, please refer to product data sheet A6V10207898.

Overview of FC722 fire control panels

Housing (Standard)		Housing (Comfort)	
FC722-ZZ	FC722-YZ With 24 indicator groups with each one red + yellow LED	FC722-ZA	FC722-ZE With 48 indicator groups with each one red + yellow LED
			
2 Loops With power supply (70 W) Battery capacity max. 12 Ah	2 Loops With power supply (70 W) Battery capacity max. 12 Ah	2 Loops With power supply (150 W) Battery capacity max. 26 Ah	2 Loops With power supply (150 W) Battery capacity max. 26 Ah
Expansion		External printer	
FH7202-Z3 Housing (Standard) 430 x 398 x 160 mm Empty housing for various applications	FH7203-Z3 Housing (Comfort) 430 x 796 x 160 mm Empty housing for various applications	FTO2001-A1 Event printer	DL3750+ Matrix printer (Extern) RS232 interface
			
e.g. for additional batteries, operating add-on or Event printer Space for batteries 2 x FA2003-A1 (7 Ah) or 2 x FA2004-A1 (12 Ah) or 2 x FA2006-A1 (26 Ah)	e.g. for additional batteries, operating add-on or Event printer Space for batteries 2 x FA2003-A1 (7 Ah) or 2 x FA2004-A1 (12 Ah) or 2 x FA2005-A1 (17 Ah) or 2 x FA2006-A1 (26 Ah)	Can be installed in all panels except – FC722-YZ RS232 module must be ordered separately	RS232 module must be ordered separately
		Operating add-on FCM7211-Y3 48 indicator groups with each one red + yellow LED	
			
		For retrofitting	

Configuration of FC722 in housing (Standard)

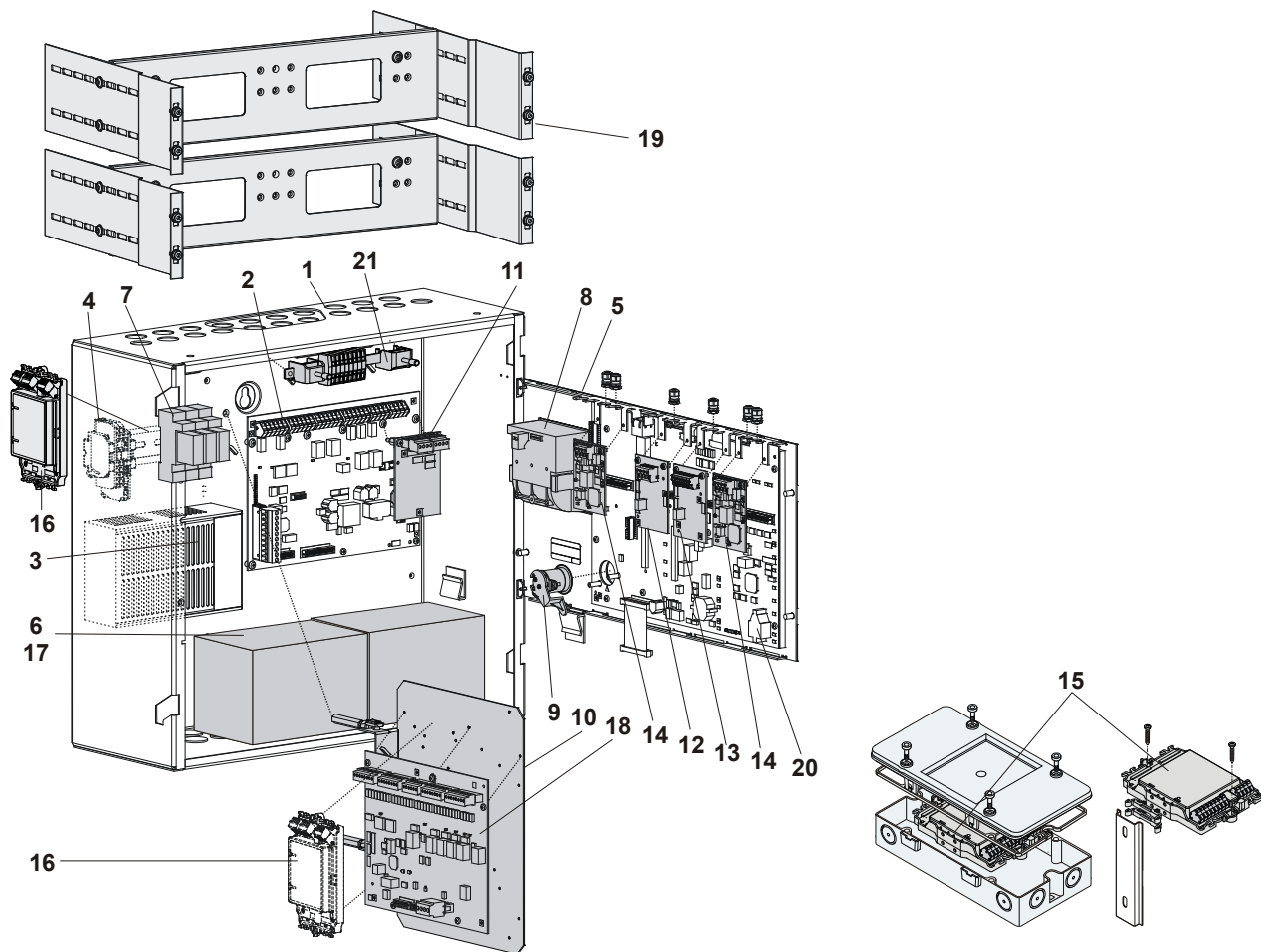

Basic equipment	Designation	Notes
1 Rear (Standard)	FHA2002-A1	
2 Periphery board (2-loop)	FCI2002-A1	Pos. 1-5 → Basic equipment for each FC722-xx (Standard)
3 Power supply (70 W)	FP2001-A1	
4 Mains terminals on DIN mounting rail TS35	–	Space for socket, relay modules, etc.
5 Operating unit	FCM72xx-xx	Combined operating unit and CPU, incl. cover
6 Space for batteries	–	2 x 12 V / 7...12 Ah
Expansion		
7 Relay module	Z3B171	Relay for fire controls
8 Event printer	FTO2001-A1	For event logging
9 Key switch (Kaba)	FTO2005-C1	For operating access rights
Key switch (Nordic)	FTO2006-B1	
10 Mounting plate	FHA2007-A1	E.g. for fire brigade peripheral
11 Loop extension (FDnet/C-NET)	FCI2003-A1	For loop extension of 2 to 4, number of addresses remains the same
12 RS485 module (isolated)	FCA2002-A1	For peripheral devices with RS485 port
13 RS232 module (isolated)	FCA2001-A1	For stations with RS232 port
14 Networking module (SAFEDLINK)	FN2001-A1	For networking various stations
15 Repeater (SAFEDLINK)	FN2002-A1	For the extension of the system bus C-WEB, max. 1 between 2 stations (mounting direct onto plane surface, onto a U-rail TS35 or in housing FDCH221)
16 Sounder module	FCA2005-A1	For split-up of 1 to 4 conventional horn lines
17 Battery (12V, 7Ah, VDS)	FA2003-A1	For emergency power supply
Battery (12V, 12Ah, VDS)	FA2004-A1	
18 Fire brigade periphery module	FCI2001-D1	For Germany (FBF, FSD, ÜE, FSE, ÖA, KL)
19 19" mounting kit	FHA2016-A1	For the installation in 3 rd party housings
20 License key L1 or License key (L2)	FCA2012-A1 FCA2013-A1	For Cerberus-Remote For Management System (also includes Cerberus-Remote)
21 Cable kit (communication)	FCA2014-A1	For flexible cable connections to the modules on the operating unit

Configuration of FC722 in housing (Comfort)

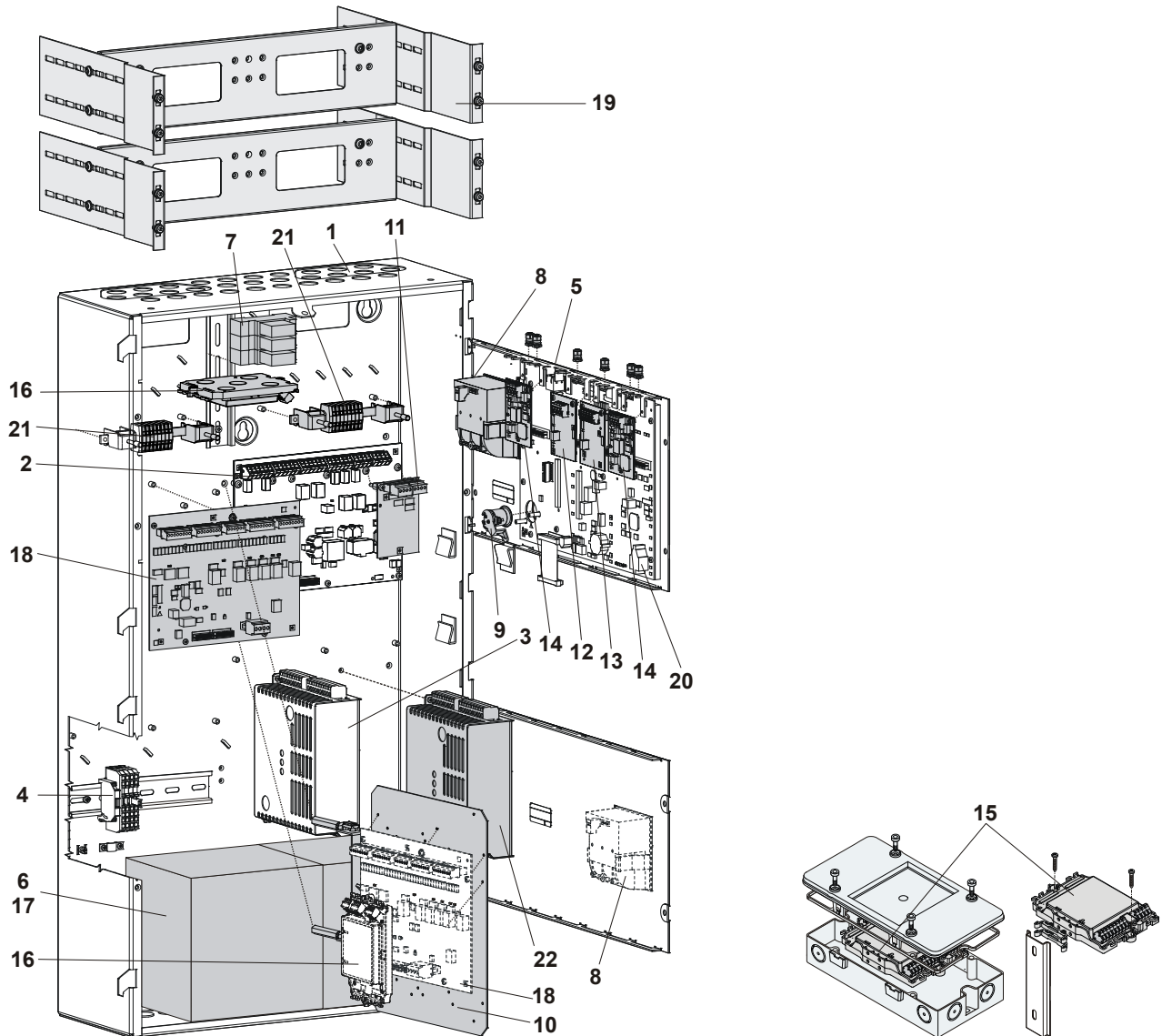

Basic equipment	Designation	Notes
1 Rear (Comfort)	FHA2003-A1	
2 Periphery board (2-loop)	FCI2002-A1	Pos. 1-5 → Basic equipment for each FC722-xx (Comfort)
3 Power supply (SV 24V-150 W)	V24230-Z6-A4	
4 Mains terminals on DIN mounting rail TS35	–	Space for socket, relay modules, etc.
5 Operating unit	FCM72xx-xx	Combined operating unit and CPU, incl. cover
6 Space for batteries	–	2 x 12 V / 7... 26 Ah
Expansion		
7 Relay module	Z3B171	Relay for fire controls
8 Event printer	FTO2001-A1	For event logging
9 Key switch (Kaba)	FTO2005-C1	For operating access rights
Key switch (Nordic)	FTO2006-B1	
10 Mounting plate	FHA2007-A1	E.g. for fire brigade peripheral
11 Loop extension (FDnet/C-NET)	FCI2003-A1	For loop extension of 2 to 4, number of addresses remains the same
12 RS485 module (isolated)	FCA2002-A1	For peripheral devices with RS485 port
13 RS232 module (isolated)	FCA2001-A1	For stations with RS232 port
14 Networking module (SAFEDLINK)	FN2001-A1	For networking various stations
15 Repeater (SAFEDLINK)	FN2002-A1	For the extension of the system bus C-WEB, max. 1 between 2 stations (mounting direct onto plane surface, onto a U-rail TS35 or in housings FDCH221)
16 Sounder module	FCA2005-A1	For split-up of 1 to 4 conventional horn lines

	Battery (12 V, 7 Ah, VDS)	FA2003-A1	
17	Battery (12 V, 12 Ah, VDS)	FA2004-A1	For emergency power supply
	Battery (12 V, 26 Ah, VDS)	FA2006-A1	
18	Fire brigade periphery module	FCI2001-D1	For Germany (FBF, FSD, ÜE, FSE, ÖA, KL)
19	19" mounting kit	FHA2016-A1	For the installation in 3 rd party housings
20	License key L1 or	FCA2012-A1	For Cerberus-Remote
	License key (L2)	FCA2013-A1	For Management System (also includes Cerberus-Remote)
21	Cable kit (communication)	FCA2014-A1	For flexible cable connections to the modules on the operating unit
22	Power supply kit (150 W, B)	FP2005-A1	For additional power supply

Technical data

	FC722 in housing (Standard)	FC722 in housing (Comfort)
Mains voltage	AC 85... 265 V	AC 98 ... 127 V / AC 196...253 V
Power supply	70 W	150 W
Operating voltage	DC 21... 28.6 V	DC 21... 28.4 V
Operating current	max. 2.5 A	max. 5 A
Battery capacity	2 x 12 V, 7... 12 Ah	2 x 12 V, 26 Ah
Battery monitoring	yes	yes
Mains monitoring	yes	yes
Connectable detector series	Cerberus PRO FD720 (C-NET)	Cerberus PRO FD720 (C-NET)
Number of lines		
– Loops (with loop extension) or	2 (4)	2 (4)
– Stub lines	4 (8)	4 (8)
Number of addresses	max. 252	max. 252
Integrated inputs/outputs		
– Relay output		
– Remote transmission alarm	1	1
– Remote transmission fault	1	1
– Monitored outputs		
– Alarm	1	1
– Fault	1	1
– Horn	1	1
– Free programmable inputs/outputs	8	8
Operating unit	integrated	integrated
Plug-in position for serial interfaces RS232, RS485	2	2
Plug-in position for network module	2	2
Plug-in position for loop extension	1	1
Mounting place for cable kit (communication)	1	2
Sounder module	max. 1	max. 1
Ethernet connection RJ45	1	1
Operating temperature	-8... +42 °C	-8... +42 °C
Storage temperature	-20... +60 °C	-20... +60 °C
Humidity (no condensation permitted)	≤95 % rel.	≤95 % rel.
Dimensions (B x H x T)		
– Without cover cap	430 x 398 x 160 mm	430 x 796 x 160 mm
– With cover cap	430 x 398 x 188 mm	430 x 796 x 188 mm
Color		
– Housing	grey, ~RAL 7035	grey, ~RAL 7035
– Cover	grey, ~RAL-Design 050 00 00	grey, ~RAL-Design 050 00 00
Protection category (IEC 60529)	IP30	IP30
Approvals		
– VdS	G209076	G209076
– LPCB	126aw/06	126aw/06

FC722

Siemens Schweiz AG, CH-6301 Zug Date: see manufacturing date on the product 0786-CPD-20721
EN54-2, EN54-4 Fire control panel, Safety in case of fire FC722 Technical data see Doc. A6V10210355

Details for ordering

	Type	Part no	Designation	Weight	
Fire control panels	FC722-ZZ	S54400-C29-A5	Fire control panel (2L)	10.660 kg	
	FC722-YZ	S54400-C29-A4	Fire control panel (2L, 1LED)	10.500 kg	
	FC722-ZA	S54400-C29-A2	Fire control panel (2L)	18.250 kg	
	FC722-ZE	S54400-C29-A1	Fire control panel (2L, 2LED)	20.850 kg	
Expansion	Z3B171	BPZ:4843830001	Relay module 250 VAC / 10 A (1 relay)	0.042 kg	
	FTO2001-A1	A5Q00010126	Event printer	0.250 kg	
	–	A5Q00017619	Replacement printer rolls (10 rolls)	0.090 kg	
	FTO2005-C1	A5Q00010113	Key switch (Kaba)	0.013 kg	
	FTO2006-B1	A5Q00010129	Key switch (Nordic)	0.050 kg	
	FHA2007-A1	A5Q00010151	Mounting plate	0.800 kg	
	FCI2003-A1	A5Q00010136	Loop extension (FDnet/C-NET)	0.064 kg	
	FCA2002-A1	A5Q00009923	RS485 module (isolated)	0.067 kg	
	FCA2001-A1	A5Q00005327	RS232 module (isolated)	0.068 kg	
	FN2001-A1	A5Q00012851	Network module (SAFEDLINK)	0.077 kg	
	FN2002-A1	S24236-B2502-A1	Repeater (SAFEDLINK)	0.154 kg	
	FCA2005-A1	A5Q00014866	Sounder module	0.140 kg	
	FCA2014-A1	A5Q00023027	Cable kit (communication)	0.224 kg	
	FCI2001-D1	A5Q00013100	Fire brigade periphery module	0.482 kg	
	FH7202-Z3	S54400-B70-A101	Housing (Standard)	7.500 kg	
	FH7203-Z3	S54400-B71-A101	Housing (Comfort)	15.000 kg	
	FCM7211-Y3	S54400-F75-A1	Operating add-on (2xLED-ind.)	2.600 kg	
	FHA2016-A1	A5Q00020179	19" mounting kit	3.000 kg	
	FN2006-A1	S54400-A109-A1	Fiber network module (SM)	0.770 kg	
	FN2007-A1	S54400-A110-A1	Fiber network module (MM)	0.770 kg	
	Additional power supply	FP2003-A1	A5Q00016005	Power supply kit (70 W)	0.650 kg
		FP2004-A1	A5Q00020825	Power supply kit (150 W) for installation in empty housing	1.366 kg
		FP2005-A1	A5Q00018779	Power supply kit (150 W, B)) for cascading	1.100 kg
Networks (backbone)	FN2008-A1	S54400-F94-A1	Ethernet switch	0.800 kg	
	FN2009-A1	S54400-F95-A1	Security module	0.800 kg	
	FHA2029-A1	S54400-B79-A1	Mounting kit for Ethernet switch (Comfort)	0.500 kg	
	FHA2030-A1	S54400-B81-A1	Mounting kit for Ethernet switch (Large Ext.)	0.500 kg	
Batteries	FA2003-A1	A5Q00019353	Battery (12 V, 7 Ah, VDS)	2.450 kg	
	FA2004-A1	A5Q00019354	Battery (12 V, 12 Ah, VDS)	3.930 kg	
	FA2005-A1	A5Q00019677	Battery (12 V, 17 Ah, VDS)	5.640 kg	
	FA2006-A1	A5Q00019356	Battery (12 V, 26 Ah, VDS)	7.572 kg	
Software license	FCA2012-A1	A5Q00018856	License key (L1)	0.010 kg	
	FCA2013-A1	A5Q00018857	License key (L2)	0.010 kg	
External printer	DL3750+	A5Q00023962	Matrix printer (Extern)	7.300 kg	
Spare part	–	A5Q00023963	Black typewriter ribbon for matrix printer DL3750+	0.078 kg	

Siemens Switzerland Ltd
Infrastructure & Cities Sector
Building Technologies Division
International Headquarters
CPS Fire Safety
Gubelstrasse 22
CH-6301 Zug
Tel. +41 41 724 24 24
www.siemens.com/buildingtechnologies

© 2012 Copyright by
Siemens Switzerland Ltd
Data and design subject to change without notice.
Supply subject to availability.

Document no. **A6V10206525_e_en_--**
Edition 04.2012

Manual FS720
Section 1